

HYXinbattery Rack Series Battery Packs

Data Parameters HYX-48100R1

HYXinbattery 48V 100Ah LiFePO4 LITHIUM BATTERY

Crafted out of Lithium Iron Phosphate (LiFePO4) technology, this is a battery built to last. With 3,000+ recharge cycles (and up to 7,000 @50%DOD) the 100 Ah provides 5 X the lifespan than your typical SLA battery. Built in smart BMS which can realize real-time monitoring the battery, Compatible with inverters of multiple brands, which can support 16 units parallel connection.



SPECIFICATIONS

Nominal Voltage	51.2V
Rated Capacity	100AH @0.2C to 40V
Stored energy	5120Wh
Cycle life@100%DOD	>3000 Cycles@100%DOD >4000 Cycles@80%DOD >7000 Cycles@50%DOD
Approx. Weight	49.5 kg
Internal Resistance	≤70.0 mΩ
Max. Charge Current	100 A
Max. Discharge Current	100 A
Charge Cut-off Voltage	58.4V
Discharge Cut-Off Voltage	40V
Dimensions	L483mm × W459mm × H175mm
Series & Parallel Connection	Maxium 16 units in parallel Connection
Operating Temperature Range	
Charge	32°F (0°C) to 113°F (45°C)
Discharge	-4°F (-20°C) to 140°F (60°C)
Storage	-4°F (-20°C) to 140°F (60°C)
Self-Discharge Rate	≤3%/month @ 25° C
Life Expectancy (years)	10 years @ 25° C
Communication Port	RS485, RS2332, CAN



COMPLIED STANDARD

- ✓ IEC 62133
- ✓ UL 1642
- ✓ ISO9001
- ✓ ISO14001
- ✓ UN38.3
- ✓ RoHS

INTELLIGENT BMS FUNCTION

- Over charge protection functio
- Over discharge protection function
- Over current protection function
- Short-circuit protection function
- Temperature protection function
- Cell Balance function
- Communicate function
- Alarm function

APPLICATIONS

RESS BESS Back-up system Data center Telecon Energy storage system

CHARACTERISTIC CURVE

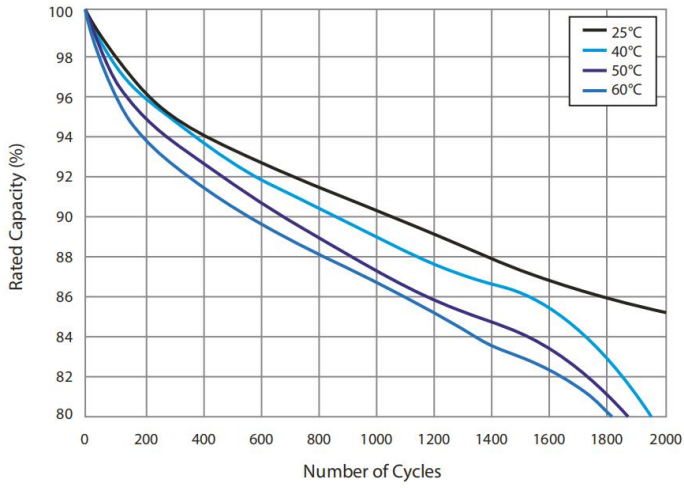

100% DOD Cycle Curves at Different Temperatures

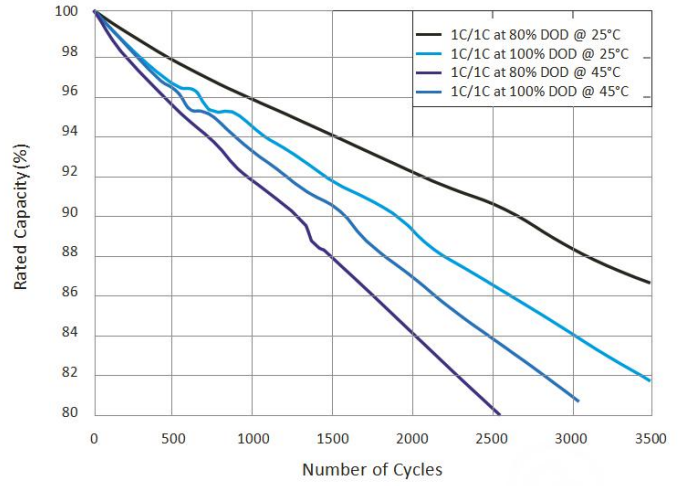

1C Cycle Curves at Different DOD & Temperatures

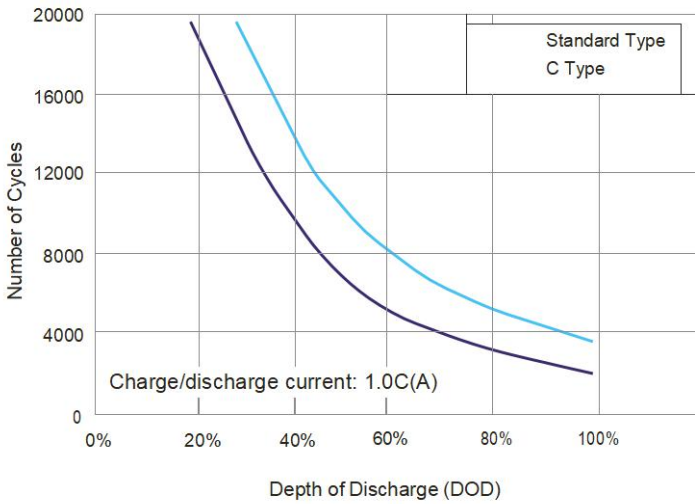

DOD in Relation to Cycle Life (25°C)

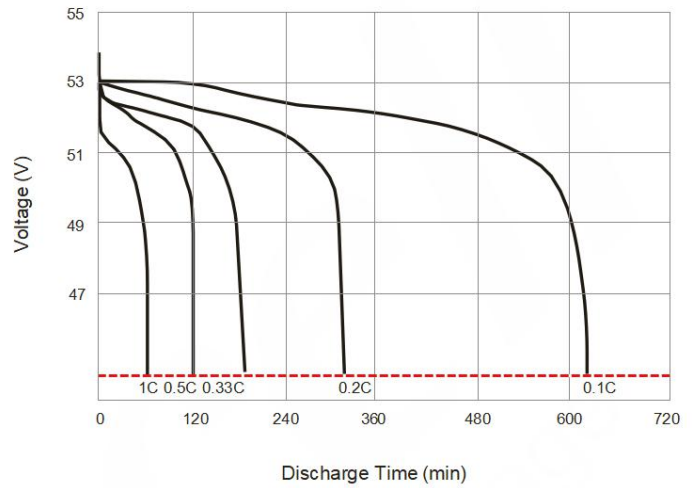

Discharge Time in Relation to Discharge Rate (25°C)

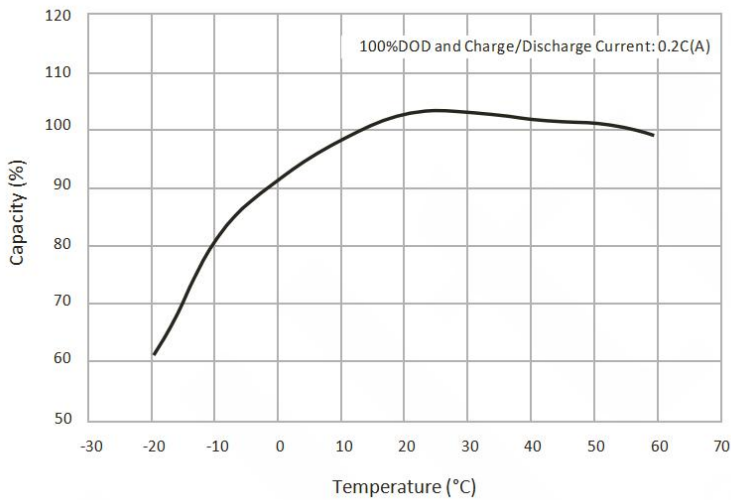

Temperature Effect in Relation to Battery Capacity

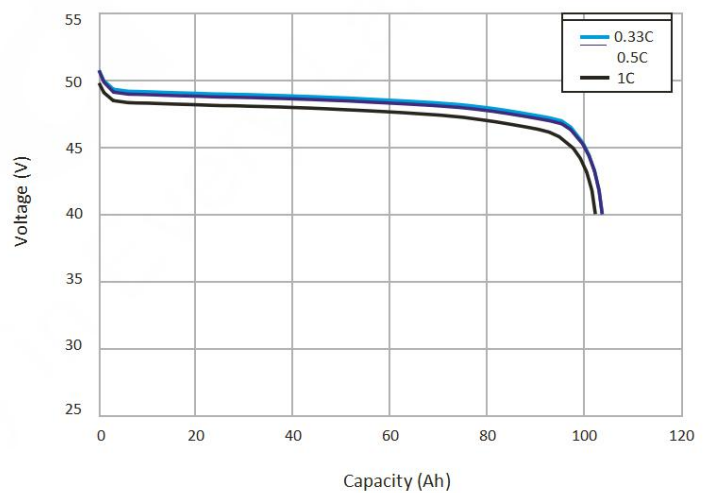

Discharge Capacity in Relation to Discharge Rate

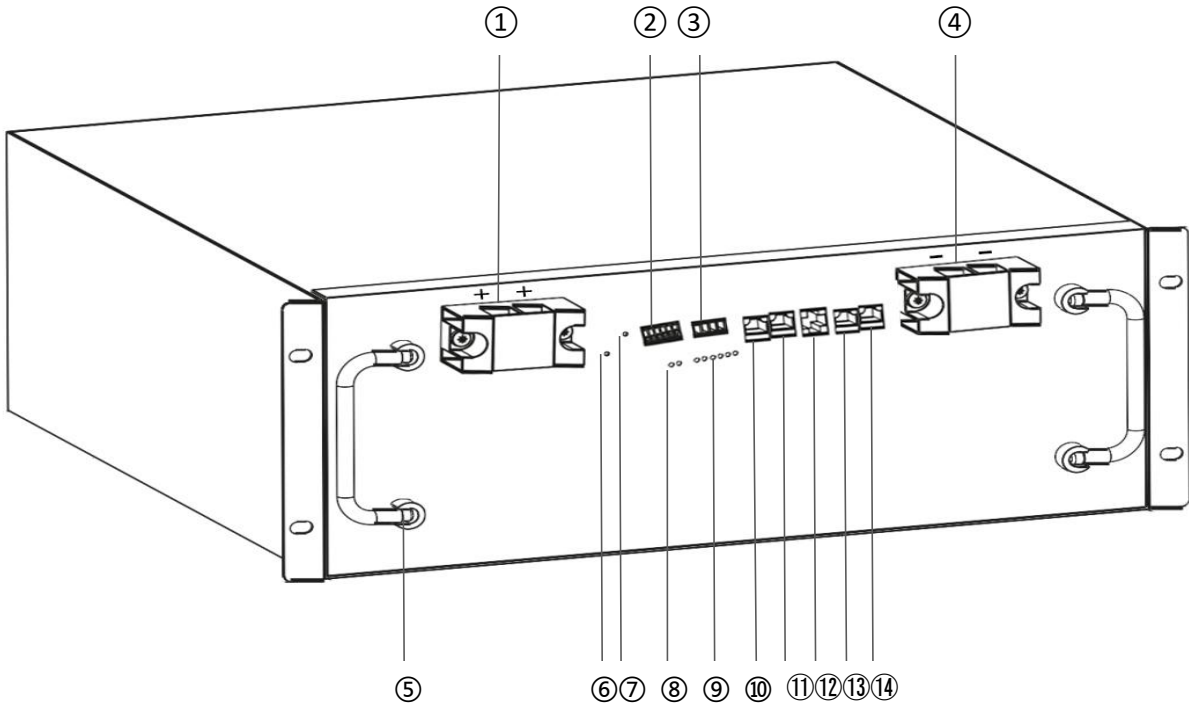

① Positive Terminal

② ADD Dialer

③ DRY CONTACT

④ Negative Terminal

⑤ SS Handle

⑥ ON/OFF Button

⑦ Reset Key

⑧ Run Indicator Light

⑨ Electricity Volume Indicator

⑩ RS485 Port

⑪ CAN Port

⑫ RS232 Port

⑬ RS485 Port

⑭ RS485 Port

BATTERY DIMENSIONS

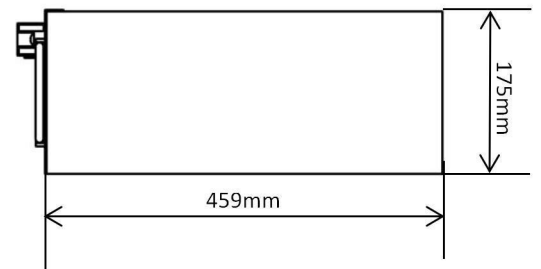
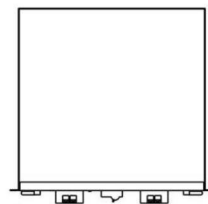
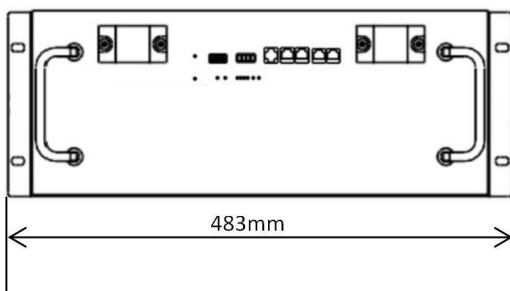

Shenzhen Heyuxin Technology Co., Ltd

2001, Building A, Zhongan Science Park, No. 117,
Huaning Road, Xinshi Community, Dalang Street, Longhua District,
Shenzhen, Guangdong

Website: www.hyxinbattery.com
Email: contact@hyxinbattery.com

